





MF, MF/MK3

MF stands for Multi-Function. The MF/MK3 is a further development of the MF.

The MF is a natural ventilator which has been specially developed to fulfil several functions together:

- day-to-day ventilation
- automatic fire ventilation

The MF can be used both to provide ventilation in all weather conditions and to extract smoke, heat and combustion gases in the event of a fire.

In addition the MF can be used to:

- provide additional daylight

The MF is a product of the Colt Group of Companies, operating world-wide with 47 establishments in 23 countries. This publication is available in a large number of languages and is internationally registered as

Publication N^o AF 1

You'll find answer forms in this publication that you can use to request further information about our organisation, products and services.

This publication is offered to you by:

Colt International Limited
New Lane, Havant
Hampshire PO9 2LY
Tel.: (0705) 451111
Fax: (0705) 454220
Telex: 86338 and 86219 Colt G



MF, MF/MK3 - construction and controls

The MF and MF/MK3 consist of 4 parts:

- 1 Uprand
- 2 Top flaps
- 3 Controls
- 4 Base



Uprand

The MF's uprstand is made from a high quality aluminium alloy AlMg. Within the casing side dampers are mounted along the whole length of the ventilator. These dampers enable ventilation to continue during bad weather, when the top flaps are closed. The long sides of the ventilator consist of aerodynamically shaped wing profiles. These ensure that the air extract is optimal, whatever the wind direction. Their shape is such that when the top flaps are closed and the side dampers are open, the unit is completely weatherproof. A rain channel between the top flaps drains the water away when the top flaps are closed. A polypropylene brush weather seal is fitted between the casing and the side dampers and top flaps to restrict the unwanted outflow of warm air to a minimum.



Technical information about the pneumatic cylinders can be found on page 10.

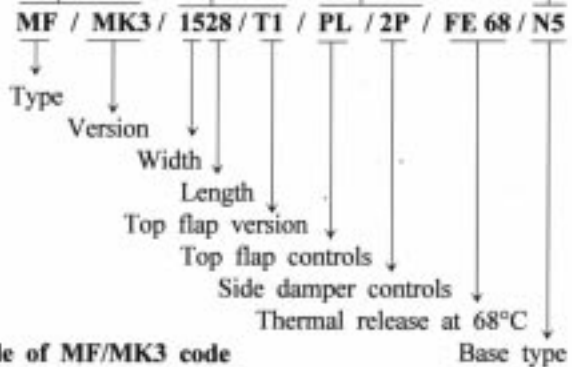

Example of MF/MK3 code

Controls

Various controls are available for opening and closing the top flaps and side dampers:

MF

- cable operated, flaps are opened by spring → L
- pneumatic control, whereby flaps are opened by pneumatic cylinder and closed by spring → P
- no controls: top flaps are fixed closed and side dampers are fixed open. → N

MF/MK3

- top flaps are opened and closed by 2 pneumatic cylinders equipped with a locking mechanism → PL
- side dampers are opened by 2 pneumatic cylinders and closed by spring → 2P

2

Top flaps

Various versions of the top flaps are available, depending on the application:

- single skinned aluminium
- single skinned transparent polycarbonate
- single skinned aluminium
- aluminium frame containing a 10 mm thick transparent polycarbonate plate

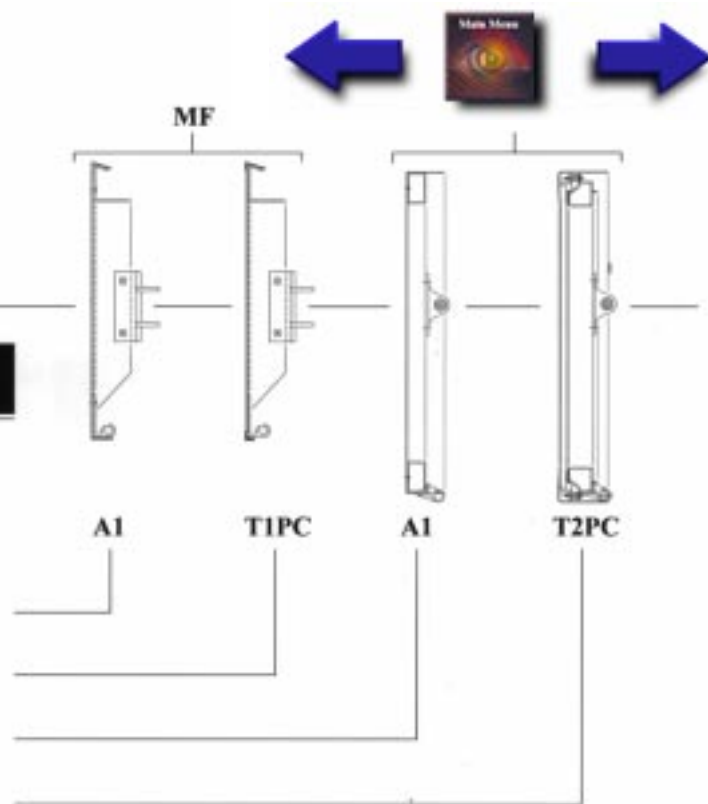

Thermal release

The control system is fitted with a fusible link as standard. In the event of fire the top flaps are opened by spring once a certain temperature has been reached. The figure after the F gives the fusing temperature of the fusible link in °C. For aluminium flaps this may be F72, F93 or F141 and for polycarbonate flaps F72 or F93.

F.. ←

VdS version

If the MF must meet VdS standards, two CO₂ cartridges are fitted. The operation remains the same as with the DIN version.

→ FD..

DIN version

An MF which is equipped with a pneumatic cylinder can be supplied to meet DIN standards. Instead of a fusible link a CO₂ cartridge and a fusible glass bulb are fitted. The glass bulb breaks when a certain temperature has been reached. The CO₂ then flows under high pressure into the cylinder, pressurising it and thus opening the unit.

FE.. ←

4

Base

Information about the bases and how the ventilator can be installed can be found on pages 9-11.



MF, MF/MK3 weights, sizes and capacity

Weights in Kg

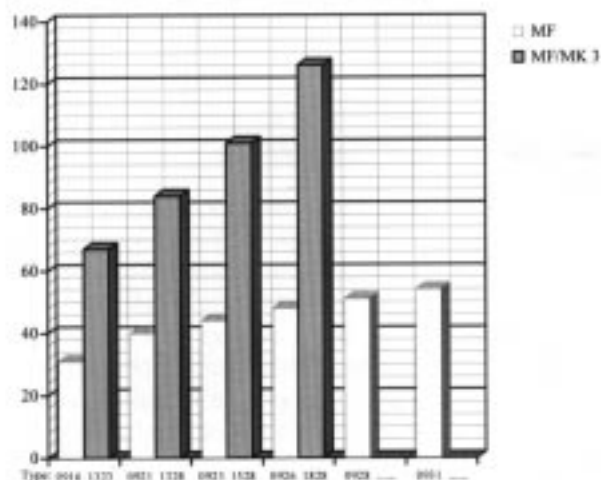

Geometric area A_v

in m^2

MF	
Type	A_v
0916	0,81
0921	1,10
0923	1,23
0926	1,40
0928	1,53
0931	1,71

MF/MK3	
Type	A_v
1323	2,00
1328	2,50
1528	3,00
1828	3,75

Roof opening

Width in mm

MF		KB*
Type	Width	Width
09..	610	825

MF/MK3	
Type	Width
13..	1000
15..	1200
18..	1500

Length in mm

MF		KB*
Type	Length	Length
..16	1300	1550
..21	1800	2050
..23	2000	2250
..26	2300	2550
..28	2500	2750
..31	2800	3000

MF/MK3	
Type	Length
..23	2000
..28	2500

* conical upstand

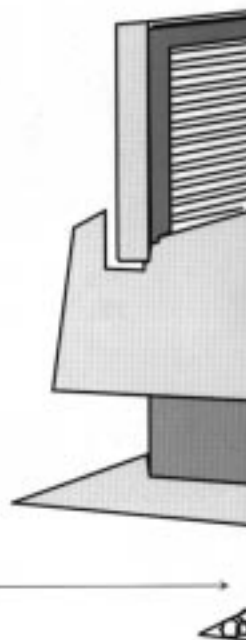



MF, MF/MK3

The type designation of the MF and MF/MK3 is based on the width and length of the ventilator, including its base. The first two figures give the width, the last two the length of the ventilator.

For example, type 0928 has a width of approx. 900mm and a length of approx. 2800mm.

Casing

Dimensions in mm

MF

Type	A	B	C
09../	1226	745	-
09../EB	1226	925	-
09../KB1	1226	775	-
09../KB3	1226	925	-

MF/MK3

Type	A	B		C
		N2-N4	N5	
../1323	1500	1007	007	100
../1328	1500	1007	1007	100
../1528	1700	1204	1104	150
../1828	2000	1495	1245	320

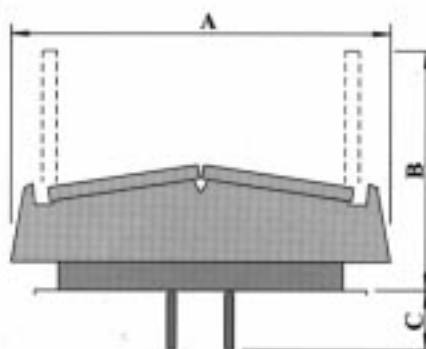

Base

Width in mm

MF

Type	N1	-	N3	N4	N5
09..	700	-	1130	1125	860

MF/MK3

Type	N2	+	N3	N4	N5
13..	1100	-	1270	1300	1250
15..	1300	-	1470	1500	1450
18..	1600	-	1770	1800	1750

Length in mm

MF

Type	N1	-	N4	N5
..16	1600	-	1850	1550
..21	2100	-	2350	2050
..23	2300	-	2550	2250
..26	2600	-	2850	2550
..28	2800	-	3050	2750
..31	3100	-	3300	3050

MF/MK3

Type	N2	-	N4	N5
..23	2300	-	2250	
..28	2800	-	2750	

The MF/MK3 is available in the following width/length combinations: **1323; 1328; 1528; 1828**

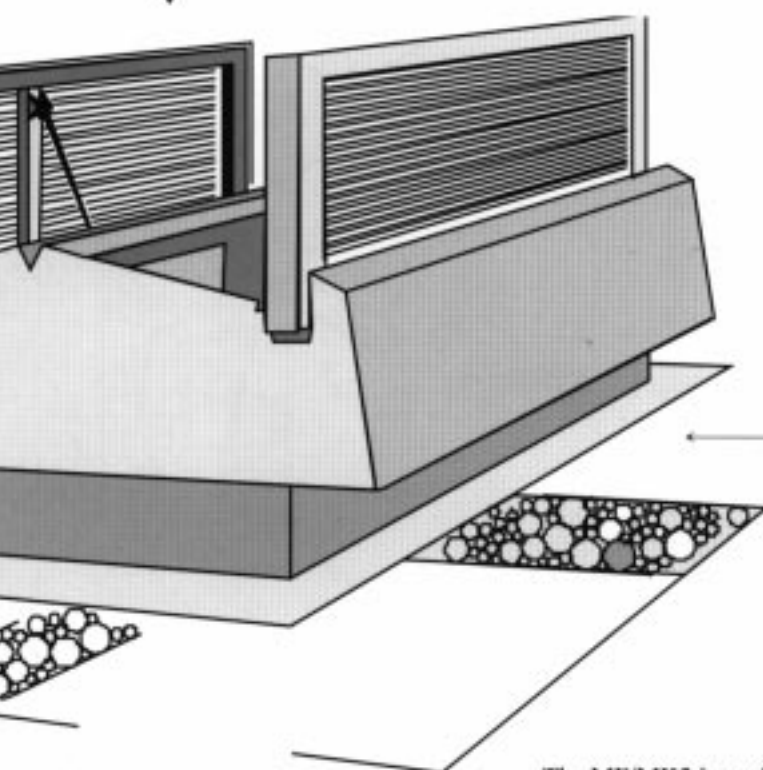



MF, MF/MK3 - controls

Pneumatic cylinder for MF type 09

MF

Cylinder type	FB00301
Quantity	1
Stroke length	150mm
Bore	40mm
Cylinder volume	0,2 l
Min pressure	6 bar
Max pressure	11 bar

Pneumatic cylinder for MF/MK3

	side dampers	top flaps	
	all types	1323; 1328	1528; 1828
Cylinder type	F0-20-60	F02-30-500	F02-40-700
Quantity	2	2	2
Stroke	60mm	500mm	700mm
Bore	20mm	30mm	40mm
Cylinder volume	0,02 l	0,35 l	0,88 l
Min pressure	6 bar	6 bar	6 bar
Max pressure	10 bar	10 bar	10 bar

We would be pleased to provide precise data about dimensions, weights, capacity and other technical matters on request.

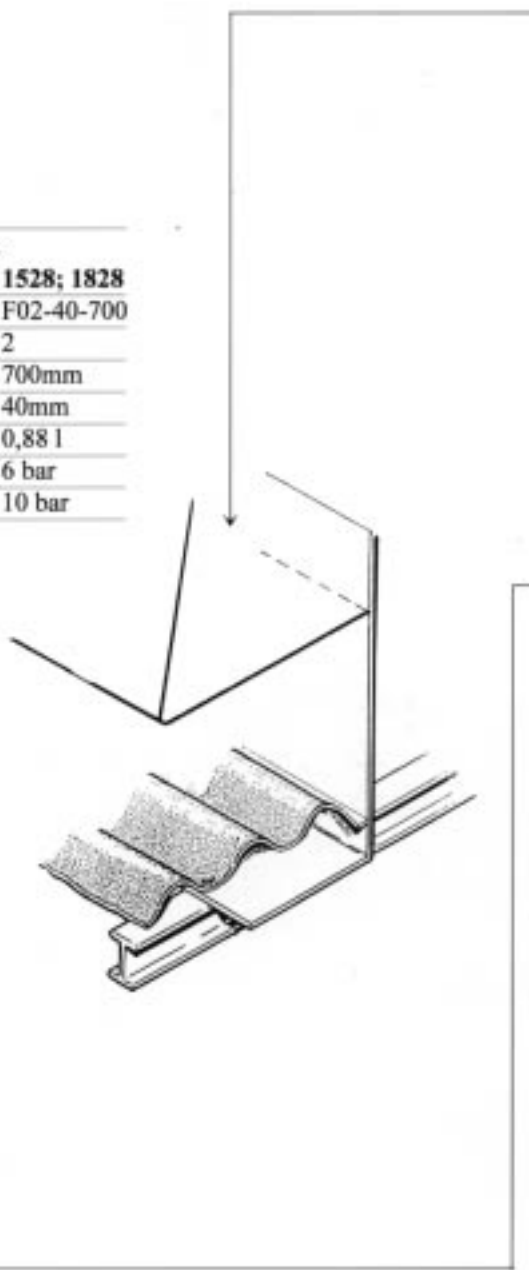
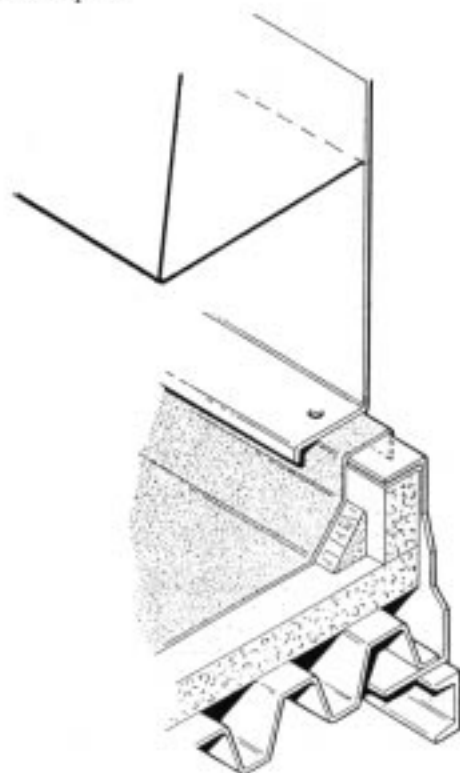



MF, MF/MK3 - alternatives for mounting

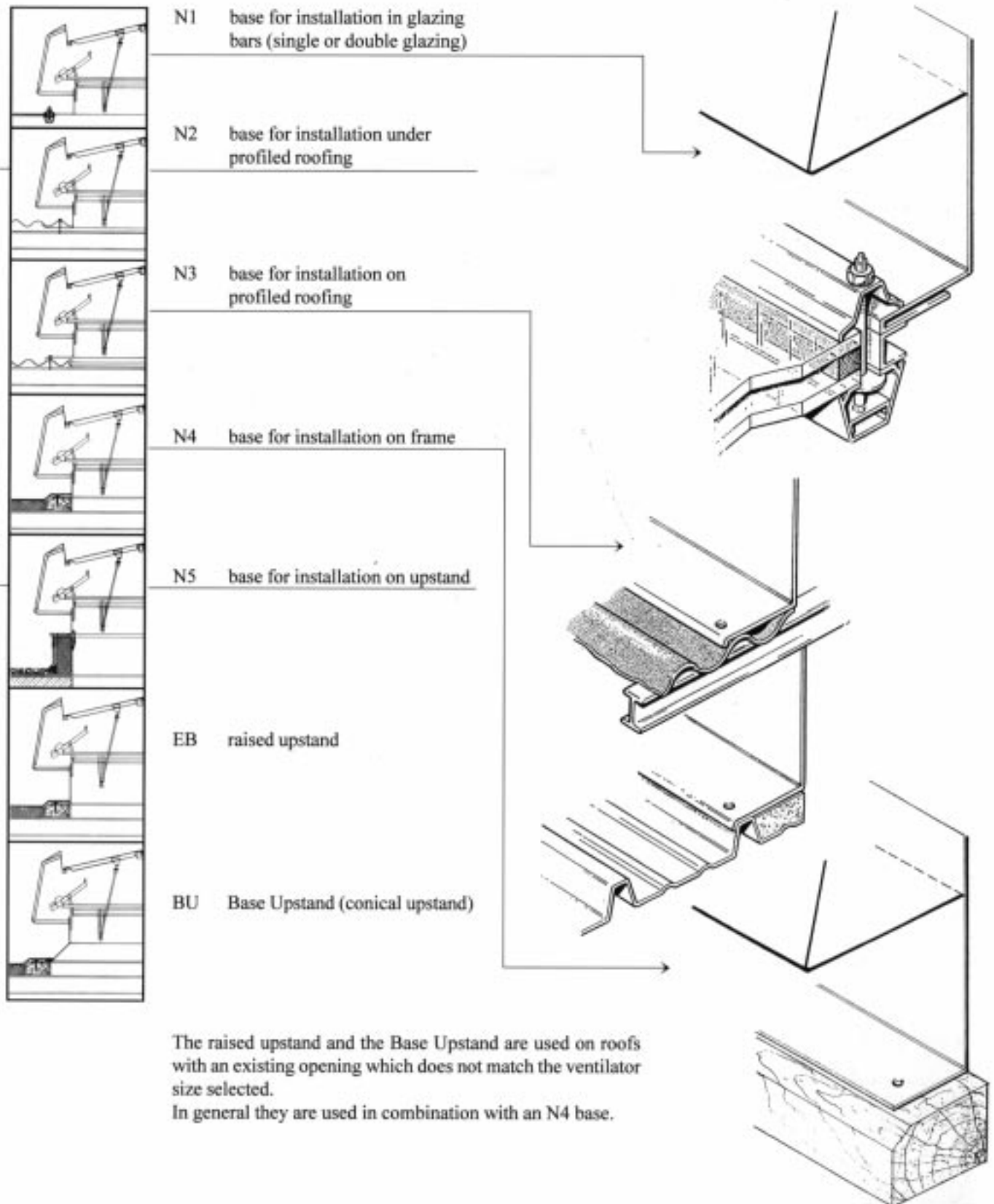



MF, MF/MK3

Installation

The MF can be installed at angles from 0 to 45° along its length. The maximum slope across its width is 3°.

The type of base used and its size are matched to the structure of the building.

The MF is a part of the Colt ventilation and fire ventilation programme. In addition to the MF, the following products are available for natural ventilation:

- Pioneer
- EuroCO
- CO/MK2-S
- VO
- Mistral
- WCO
- WCCO
- Meteor MLS
- Kameleon
- Labyrinth

Colt also has an extensive programme for mechanical ventilation. If you would like to know more about this subject, please ask for our publications.

Colt can provide a complete service:

- analysis
- advice
- production
- installation and
- maintenance

of systems for environmental control and fire ventilation.

The MF as fire ventilator. In the event of fire, heat, smoke and combustion gases are exhausted automatically, directly to the atmosphere.

Maximum ventilation with the top flaps open. The MF has an extremely high ventilation capacity in comparison with other ventilators of the same size.

In bad weather the MF ventilates via the side dampers. If the unit is controlled pneumatically it is possible to install a rain detector to provide automatic control.

Sealing brushes around the flaps prevent the loss of air and thus warmth when the ventilator is closed.

The unit can provide additional daylight to the workplace through transparent flaps or when it is fully opened.